

## II Maths

### Counting Chart: Numbers 1 to 100

1 one	2 two	3 three	4 four	5 five	6 six	7 seven	8 eight	9 nine	10 ten
11 eleven	12 twelve	13 thirteen	14 fourteen	15 fifteen	16 sixteen	17 seventeen	18 eighteen	19 nineteen	20 twenty
21 twenty- one	22 twenty- two	23 twenty- three	24 twenty- four	25 twenty- five	26 twenty- six	27 twenty- seven	28 twenty- eight	29 twenty- nine	30 thirty
31 thirty- one	32 thirty- two	33 thirty- three	34 thirty- four	35 thirty- five	36 thirty- six	37 thirty- seven	38 thirty- eight	39 thirty- nine	40 forty
41 forty- one	42 forty- two	43 forty- three	44 forty- four	45 forty- five	46 forty- six	47 forty- seven	48 forty- eight	49 forty- nine	50 fifty
51 fifty- one	52 fifty- two	53 fifty- three	54 fifty- four	55 fifty- five	56 fifty- six	57 fifty- seven	58 fifty- eight	59 fifty- nine	60 sixty
61 sixty- one	62 sixty- two	63 sixty- three	64 sixty- four	65 sixty- five	66 sixty- six	67 sixty- seven	68 sixty- eight	69 sixty- nine	70 seventy
71 seventy- one	72 seventy- two	73 seventy- three	74 seventy- four	75 seventy- five	76 seventy- six	77 seventy- seven	78 seventy- eight	79 seventy- nine	80 eighty
81 eighty- one	82 eighty- two	83 eighty- three	84 eighty- four	85 eighty- five	86 eighty- six	87 eighty- seven	88 eighty- eight	89 eighty- nine	90 ninety
91 ninety- one	92 ninety- two	93 ninety- three	94 ninety- four	95 ninety- five	96 ninety- six	97 ninety- seven	98 ninety- eight	99 ninety- nine	100 one hundred

### 1. WHAT IS LONG? WHAT IS ROUND?

This is Round

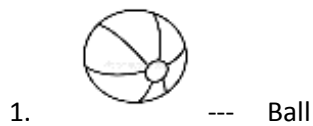

4.  --- watch

5.  ---- coin

This is long

1.  ---- bat



1.  ---- hockey stick



2.  ---- pencil



3.  ---- tubelight



4.  ---- scale



II. What is round in shape? Put a (✓) mark.

1.  



2.  



3.  



4.  

5.  

III. What is long? Put (✓) mark

1.  

2.  

3.  



### III. Draw things that rolls

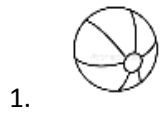

- Ball



- Pencil



- Coin



- Water bottle



- bangle



- tyre



- tomato